



BioPress UVC 1000 / 1600 / 2400

Operating instructions
Notice d'emploi
Instrucciones de uso



REMINDER

CALL 1-888-627-3435
BEFORE RETURNING TO STORE.

Part	Description	QTY
A	Black hose adapter with nut and seal	2
B	Transparent stepped hose adapter	2
C	Flow indicator	1
D	Nut	3
E	Unit	1
F	Hose clamp	1

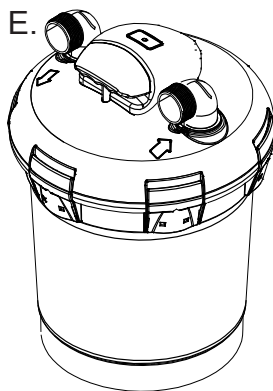
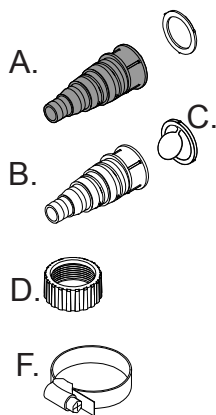

Information about these operating instructions

Welcome to OASE Living Water. You made a great choice with the purchase of this product **BioPress UVC 1000 / 1600 / 2400**. Prior to operating the unit, please read the instructions of use carefully and fully familiarise yourself with the unit. Ensure that all work on and with this unit is only carried out in accordance with these instructions. Please strictly follow the enclosed instructions to ensure safe and correct handling of the product. Keep these instructions in a safe place. Please also hand over the instructions when passing the unit on to a new owner.

WARNINGS AND CAUTIONS SYMBOLS

Symbols used in these instructions

The symbols used in this operating manual have the following meanings:



Risk of injury to persons due to dangerous electrical voltage.

This symbol indicates an imminent danger, which can lead to death or severe injuries if the appropriate measures are not taken.



Risk of personal injury caused by a general source of danger.

This symbol indicates an imminent danger, which can lead to death or severe injuries if the appropriate measures are not taken.



Risk of injury to persons due to broken glass.

This symbol indicates danger, which can lead to severe injuries if the appropriate measures are not taken.



Important information for trouble-free operation.

Intended use

BioPress UVC 1000 / 1600 / 2400, referred to in the following as “unit”, may only be used as specified in the following:

- For operation with clean water.
- For mechanical and biological cleaning of garden ponds
- Operation under observance of the technical data.

The UVC lamp installed in the unit is intended to kill algae and bacteria in the pond water. Even in small doses, its radiation is harmful for eyes and skin. Never use the UVC lamp in a defective housing or outside the housing, or any other purpose other than that intended.

The following restrictions apply to the unit:

- Never use the unit to convey fluids other than water.
- Never run the unit without water.
- Do not use for commercial or industrial purposes.
- Do not use in conjunction with chemicals, foodstuff, easily flammable or explosive substances.

Use other than that intended

This unit can be dangerous and cause harm if not used in accordance with these instructions. Any use not in accordance with these instructions or modification(s) to the unit will void the limited warranty.

Questions, problems, missing parts?

Before returning to your retailer, call us at 1-866-627-3435, 8 a.m.-6 p.m., EST, Monday-Friday, or email us at customer@oase-livingwater.com. Or visit our website at www.oase-livingwater.com

Installation



Attention! Dangerous electrical voltage.

Possible consequences: Death or serious injuries.

Protective measures:

- Only operate the unit with the protection hood fitted.
- Ensure that the unit is installed water-tight with a safety distance from the water of a minimum of 6.6 ft (2 m).



Grounding instructions

This appliance must be grounded. In the event of a malfunction or breakdown, grounding will reduce the risk of electric shock by providing a path of least resistance for electric current. This appliance is equipped with a cord having an appliance-grounding conductor and a grounding plug. The plug must be plugged into an appropriate outlet that is installed and grounded in accordance with all local codes and ordinances.

Warning

Improper connection of the appliance-grounding conductor can result in a risk of electric shock. Check with a qualified electrician or service representative if you are in doubt whether the appliance is properly grounded. Do not modify the plug provided with the appliance; if it will not fit the outlet, have a proper outlet installed by a qualified technician.

Install the unit so that it is not exposed to direct sun radiation (max. 104 °F - 40 °C).

1. Place the pressure filter in a flood protected position at a distance from the pond edge of at least 6.6 ft (2 m) on firm and level ground. As an alternative, the filter can also be partly buried up to approx. 2 in (5 cm) below the closing clamps.
 - o The height difference between the filter lid and the free outlet point should be a maximum of 6.6 ft (2 m).
 - o Ensure unrestricted access to the cover to be able to carry out work on the unit.

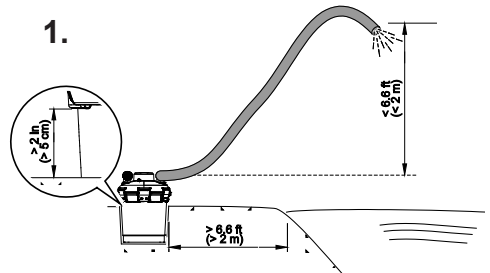

2. Cut the adapter as shown using a hacksaw; consult packaging for tubing size. This helps to avoid pressure loss. (BioPress 1600 / 2400 only)
3. Push the union nuts over the stepped hose adapters, push the tubing on the on the stepped hose adapter, and secure with the hose clips.
4. Insert the flat sealing ring or the O ring into the union nut for the black hose adapter and screw onto the pressure filter inlet.

BioPress 1600 / 2400

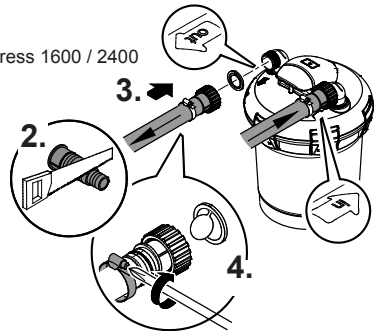

BioPress 1000

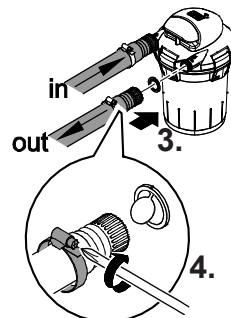

Start-up

⚠ Attention! Dangerous electrical voltage.
Possible consequences: Death or serious injuries.

Protective measures:

- Electrical units and installations with a rated voltage of $U > 12 \text{ V AC}$ or $U > 30 \text{ V DC}$ located in the water: Isolate the units and installations (switch off and disconnect from the power supply) before reaching into the water.
- Isolate the unit before starting any work.
- Secure the unit to prevent unintentional switching on.

⚠ Attention! Never operate the unit with a water pressure of more than 2.9 psi (0.2 bar)

Important:

- Switch the pump on first, then the UVC clarifying unit.
- Do not operate the unit without water flowing through.
- The unit switches on automatically when power connection is established.

- 1. Switching on:** Connect power plug to the socket.
- The Light Indicator is lit.

Note:

- After a new installation, the unit will reach its full biological cleaning effect after a few weeks.
- The full effect on bacteria is only reached as at a water temperature of $50 \text{ }^\circ\text{F}$ ($+ 10 \text{ }^\circ\text{C}$).
- In the event of overheating, the installed temperature monitor switches the UVC lamp off automatically, the lamp automatically switches on again once cooled down.
- Check all connections for leaks.

- 2. Switching off:** Disconnect the power plug.

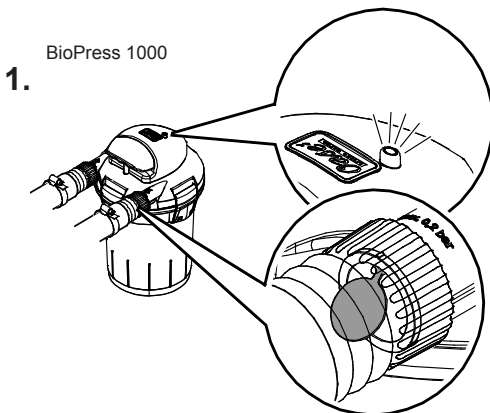
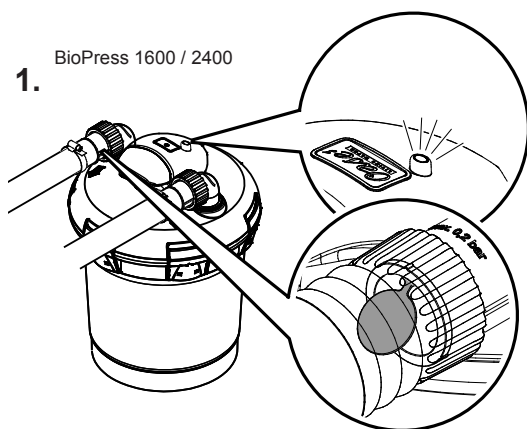

Questions, problems, missing parts?

Before returning to your retailer, call us at 1-866-627-3435, 8 a.m.-6 p.m., EST, Monday-Friday, or email us at customer-care@oase-livingwater.com. Or visit our website at www.oase-livingwater.com

Maintenance and cleaning



Attention! Dangerous electrical voltage.

Possible consequences: Death or serious injuries.

Protective measures:

- Electrical units and installations with a rated voltage of $U > 12 \text{ V AC}$ or $U > 30 \text{ V DC}$ located in the water: Isolate the units and installations (switch off and disconnect from the power supply) before reaching into the water.
- Isolate the unit before starting any work.
- Secure the unit to prevent unintentional switching on.

Note:

- Check and clean the water outlet into the pond at regular intervals.
- Clean the filters at regular intervals (e.g. every four weeks), however, at the latest when cloudy or dirty water from the water outlet returns to the garden pond.
- Carry out quick cleaning first. Should this prove insufficient, clean the entire unit.
- A blocked filter could lead to leakages.
- Never use chemical cleaning agents.

Quick cleaning

1. Switch off the filter pump

- Remove hose from the filter outlet by twisting off the union nut.
- Remove hose from the filter inlet by twisting off the union nut and screw on the filter outlet.

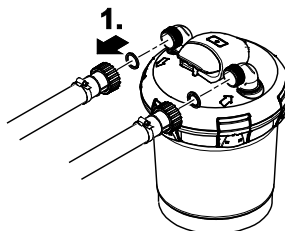

2. Screw a dirt drain hose with stepped hose adapter on the filter inlet.

- Switch on the filter pump.

BioPress 1600 / 2400

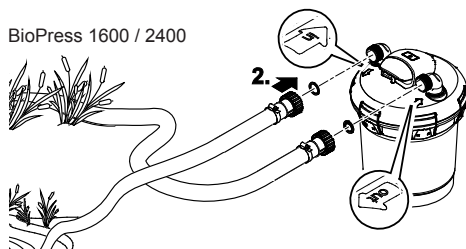

BioPress 1000

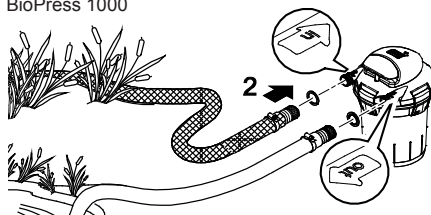

3. Vigorously pull on the cleaning handle and “pump” several times. In this manner, the foam filters are mechanically cleaned until the draining water is clear.

- Switch off the filter pump.
- Remove the dirt drain hose and correctly reconnect the hoses for normal operation.

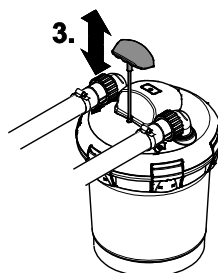

Maintenance and cleaning (cont.)

Full cleaning

1. Disconnect all hoses by twisting off the union nuts.
2. Open the closing clamps of the filter container.
 - BioPress 1000: Hold the filter container at the hold-down element and lift off cover including the foam filter package.
 - BioPress 1600/2400: Lift off cover including foam filter package.
3. Lift off cover including foam filter package.
4. Place the cover upside down onto a soft, clean surface, so that the foam filters with the press ring face up.
 - Remove the press ring by undoing the nut from the pulling rod.
 - To remove the nut, hold the pulling rod using combination pliers.

Note: Do not pull the pulling rod out of the cover.

5. Pull off the foam filters.
6. Clean under running water by vigorously compressing and releasing.
 - Clean the container, cover with meshed tube and press ring under running water.
7. Push on foam filters so that the pulling rod rests in the recess of the foam filters.
8. Fit the pressing ring with the rod guidance pointing down, and screw the nut onto the pulling rod.
 - To tighten the nut, hold the pulling rod using combination pliers.
 - Ensure that the meshed tube fits completely in the ring diameter.
 - Remove the cover sealing ring from the container and check for damage; clean or replace, and place on the top container rim.
9. Press on the cover including the foam filter package, allow the closing clamps to engage.
 - Perform a quick cleaning (Section: Quick cleaning).

BioPress 1600 / 2400

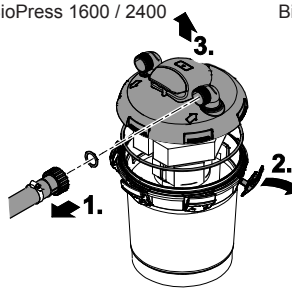

BioPress 1000

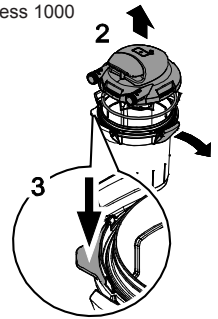

0.3 in
(8 mm)

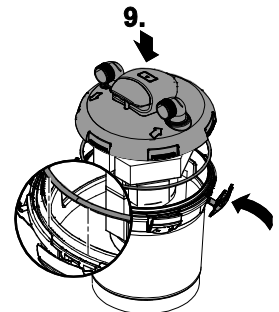
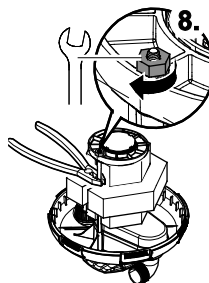
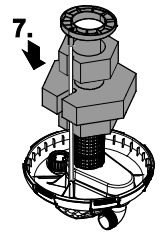
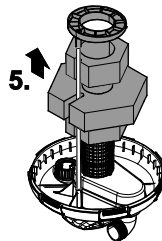
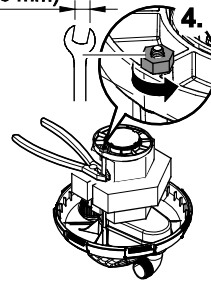

Questions, problems, missing parts?

Before returning to your retailer, call us at 1-866-627-3435, 8 a.m.-6 p.m., EST, Monday-Friday, or email us at customer@oase-livingwater.com. Or visit our website at www.oase-livingwater.com

Cleaning the quartz glass / Replacing the UVC lamp

- ⚠ Attention! Ultra-violet radiation.**
Possible consequences: Eye or skin injury from burns
Protective measures:
- Never operate the UVC lamp outside its housing.
 - Never operate the UVC lamp in a housing that is defective

- ⚠ Danger:** Ultraviolet radiation.
Do not expose eyes to lamp rays.
Disconnect power before servicing or replacing lamp.
Replace lamp only with lamp rated 9 watts:

Warning: To reduce the risk of electric shock - Connect only to a circuit that is protected by a ground-fault circuit interrupter (GFCI)

For indoor and outdoor household use

- 🍷 Attention! Breakable glass**
Possible consequences: Injury to your hands caused by cuts
Protective measures: Handle the quartz glass and UVC lamp with care.

- 👤 Note!**
For safety reasons the UVC lamp can only be switched on when the unit head has been correctly fitted into the casing.

Opening the UCV clarifying unit

1. Remove the cover from the UVC clarifying unit.
 - Turn the UVC clarifying unit counter-clockwise up against the stop (bayonet closure), then carefully pull out of the filter cover including the O ring.
2. Loosen the self-tapping screw until the the screw tip is sunk in the housing of the clamping screw.
3. Unscrew the clamping screw counter-clockwise.

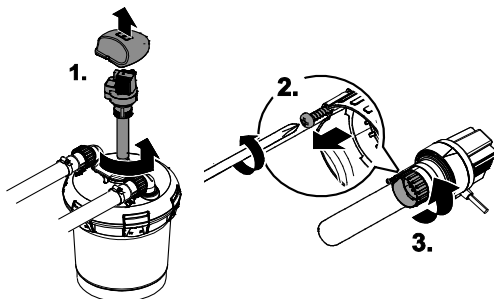

4. Remove the quartz glass including the O ring towards the front with a slight turning movement.
 - Check the quartz glass and the O ring for damage and replace, if necessary.
 - Clean the quartz glass outer face with a moist cloth.

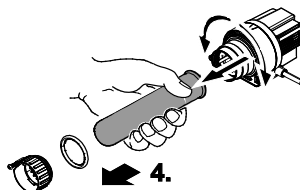

Cleaning the quartz glass / Replacing the UVC lamp (cont.)

Replacing the UVC lamp

Important:

- Only use lamps the identification and capacity data of which correspond to the information on the type plate.
- For an optimum filter performance, we recommend to replace the UVC lamp every year after approx. 8,000 operating hours.

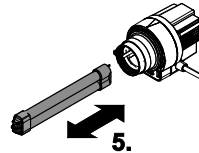

5. Pull out and replace the UVC lamp.

Assembly of the UVC clarifying unit

6. Insert the quartz glass including the O ring against the stop in the unit head.
- Press the O ring into the gap between unit head and quartz glass.

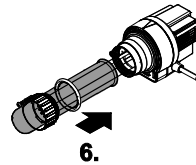

7. Tighten the clamping screw clockwise up to the stop.
8. Tighten the self-tapping screw.

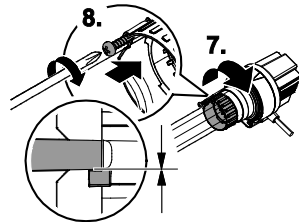

9. Check the O-Ring at the unit head for damage and replace, if necessary.
- Carefully push the unit head into the housing while applying slight pressure. Ensure that the tenons at the housing engage in the grooves of the bayonet closure.
 - Turn the unit head clockwise against the stop while applying slight pressure.
 - Refit the cover for the UVC pre-clarifying unit.

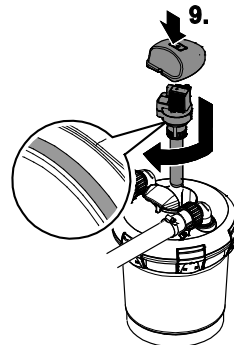

Questions, problems, missing parts?

Before returning to your retailer, call us at 1-866-627-3435, 8 a.m.-6 p.m., EST, Monday-Friday, or email us at customer@oase-livingwater.com. Or visit our website at www.oase-livingwater.com

Storage/Winterization

- Pull out and replace the UVC lamp (Section: Replacing the UVC lamp).
- Put the unit out of operation at water temperatures below 46 °F (8 °C) or, at the latest, when freezing temperatures are to be expected.
- Drain and thoroughly clean the unit, check for damage.
- Remove, clean, dry and store all filters in a frost-free environment.
- Ensure that the storage place is inaccessible to children.
- Cover the filter container such that the ingress of rain water is excluded.
- Drain all hoses, pipes and connections.

Wear parts

The UVC lamp, the quartz glass and the filters are wear parts and are excluded from the warranty.

Disposal



Do not dispose of this unit with domestic waste! Disable the unit beforehand by cutting off the cables. Further information about the recycling of this product can be obtained from your local municipal authority.

Troubleshooting

Issue	Cause	Solution
The unit performance is not satisfactory	Unit has been in operation only for a short time	The complete biological cleaning effect is only achieved after several weeks
	Water extremely soiled	Remove algae and leaves from the pond, change the water
	Excessive fish and animal population	Guide value: approx. 2 ft (60 cm) fish length in 265 gal (1 m ³) pond water
	Foam filters soiled	Clean filters
	Quartz glass tube soiled	Remove UVC and clean quartz glass
	UVC lamp capacity exhausted	Replace the lamp after approx. 8,000 operating hours
UVC lamp display is not lit	Power supply of the UVC not connected	Connect UVC power plug
	UVC lamp defective	Replace the UVC lamp
	Connection defective	Check electrical connection
	UVC overheated	UVC automatically switches on when cooled down
No water outlet from the pond inlet	Pump power supply not connected	Connect pump power supply
	Pond inlet blocked	Clean pond inlet
	Filter container/pump housing clogged	Clean filter container/pump housing



OASE North America INC. · www.oase-livingwater.com

46635/09-16